

KYP-140H

- Oil-less, non-lube piston and cylinder
- Durable Valves
- Balanced for smooth, low vibration operation long-life
- Permanently lubricated motor shaft and connecting rod bearings
- Low sound levels
- Field service capability

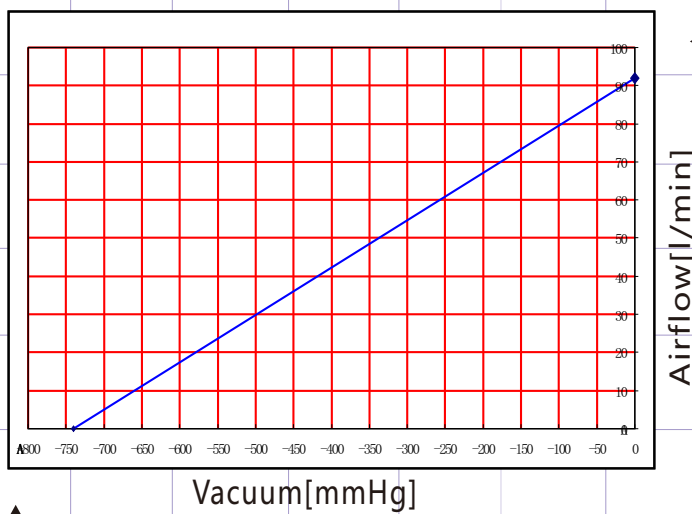

Airflow Curve



Specification

Model	KYP-140H	
Outlet Airflow	92	105L/min
Rated Voltage	AC220/115V	
Frequency	50	60Hz
Input power	450W	
Maximum Pressure	-	
Maximum Vacuum	-98.6KPa(-740mmHg)	
Sound Level	56dB	
Weight	8.4Kg	
Dimensions	240X134X198mm	
Ambient Temperature	0 deg.c to 45 deg.c	

Dimensions mm

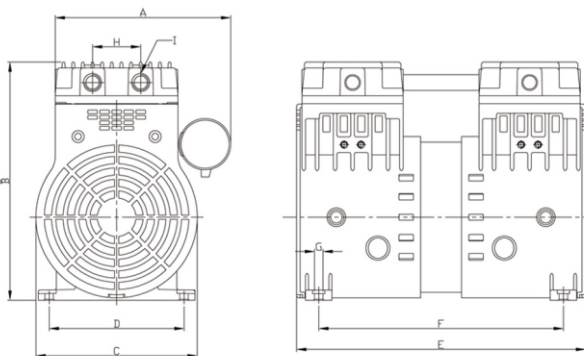

A	B	C	D	E	F	G	H	I
146	198	∅134	112	240	203.5	∅7	40	G1/4"

Accessory

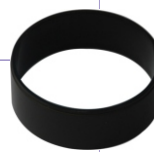

Cylinder



Cap seal



Damping feet



Filter



Silencer

Application Examples

- Electronic
- Medical
- Automatic
- Instrument
- printing
- Food
- Packing
- Plastic
- Textile
- Chemical
- Aquaria
- Waste water