

KYP-140V

- Oil-less, non-lube piston and cylinder
- Durable Valves
- Balanced for smooth, low vibration operation long-life
- Permanently lubricated motor shaft and connecting rod bearings
- Low sound levels
- Field service capability

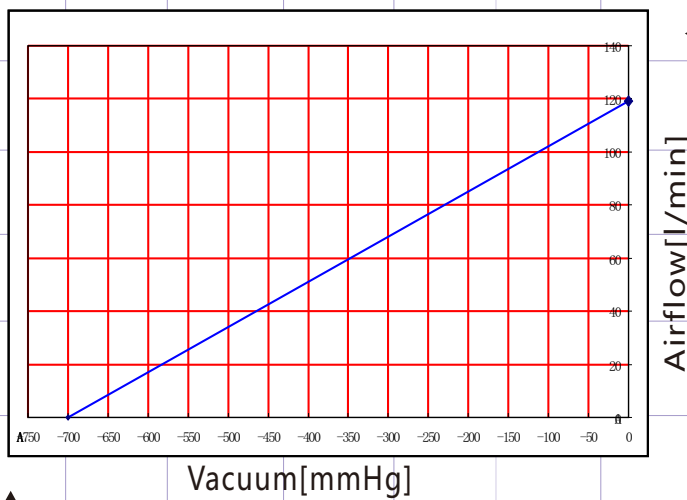

Airflow Curve



Specification

| | | |
|---------------------|---------------------|----------|
| Model | KYP-140V | |
| Outlet Airflow | 119 | 143L/min |
| Rated Voltage | AC220/115V | |
| Frequency | 50 | 60Hz |
| Input power | 450W | |
| Maximum Pressure | - | |
| Maximum Vacuum | -93KPa(-700mmHg) | |
| Sound Level | 56dB | |
| Weight | 8.4Kg | |
| Dimensions | 240X134X198mm | |
| Ambient Temperature | 0 deg.c to 45 deg.c | |

Dimensions mm

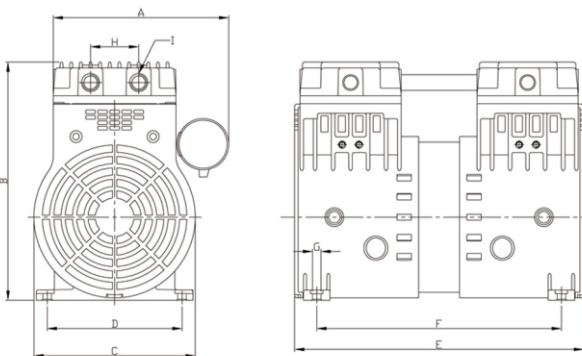

| A | B | C | D | E | F | G | H | I |
|-----|-----|------|-----|-----|-------|----|----|-------|
| 146 | 198 | ∅134 | 112 | 240 | 203.5 | ∅7 | 40 | G1/4" |

Accessory

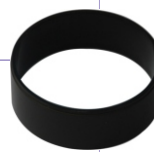

Cylinder



Cap seal



Damping feet



Filter



Silencer

Application Examples

- Electronic
- Medical
- Automatic
- Instrument
- printing
- Food
- Packing
- Plastic
- Textile
- Chemical
- Aquaria
- Waste water